

**DMT80600T104-31WT**  
**User Guide**

**Revision on April, 2014**



# Contents

**1. Overview..... 2**

**2. System Specifications ..... 2**

**3. Operating Guide ..... 4**

    3.1 Update the Boot Animation..... 4

    3.2 Hide / Show the Status Bar ..... 5

    3.3 Brightness..... 5

    3.4 Sound ..... 6

    3.5 WI-FI..... 6

    3.6 Ethernet ..... 7

    3.7 3G Mobile Manager ..... 8

    3.8 File Manager ..... 9

    3.9 Install and Uninstall Applications ..... 9

    3.10 Show Touches ..... 10

    3.11 Touch-screen Calibration..... 10

    3.12 Serial Testing..... 11

    3.13 Connect to PC ..... 12

    3.14 Backup & Reset ..... 12

**4. Revision ..... 13**

## 1. Overview

DWIN Android Series range from 7-inch (800x480), 8-inch (800x600), 9.7-inch (1024x768), 10.4-inch (800x600), and 15-inch (1024x768) on size and support VGA/HDMI interface. This manual will mainly introduce operation and use of DMT80600T104-31WT as resistive panel with following features:

- ✧ Power in wide range of voltage: +6V ~ +42V , or +5V;
- ✧ 24 bit RGB true color;
- ✧ 1GHz Dual Core, 512MB DDR3, 4GB NAND Flash, high performance in low power consumption;
- ✧ Both resistive panel and none-touch in option;
- ✧ Analog video supporting PAL/NTSC, photograph as well as video shooting;
- ✧ Two USB hosts, supporting USB 3G dongle, USB Camera, USB Disk, USB Keyboard, USB Mouse and etc;
- ✧ Micro SD card supported;
- ✧ Four UART, TTL and RS 232 level supported;
- ✧ 10M/100M Ethernet, 802.11b/g/n WLAN supported;
- ✧ Video playback up to 1080P in the formats of H.264, VC-1, MPEG-2, MPEG-4 and Real Video;
- ✧ Video Encoding up to 1080P in the format of H.264;
- ✧ 1 W Audio Power Amplifier provided, Microphone interface provided;
- ✧ Android 4.1;

## 2. System Specifications

DWIN Android product features powerful CPU processing capability, gorgeous user experience, fluent 1080P decoding/encoding and a variety of optional peripheral resources. Take DMT80600T104-31WT as example.

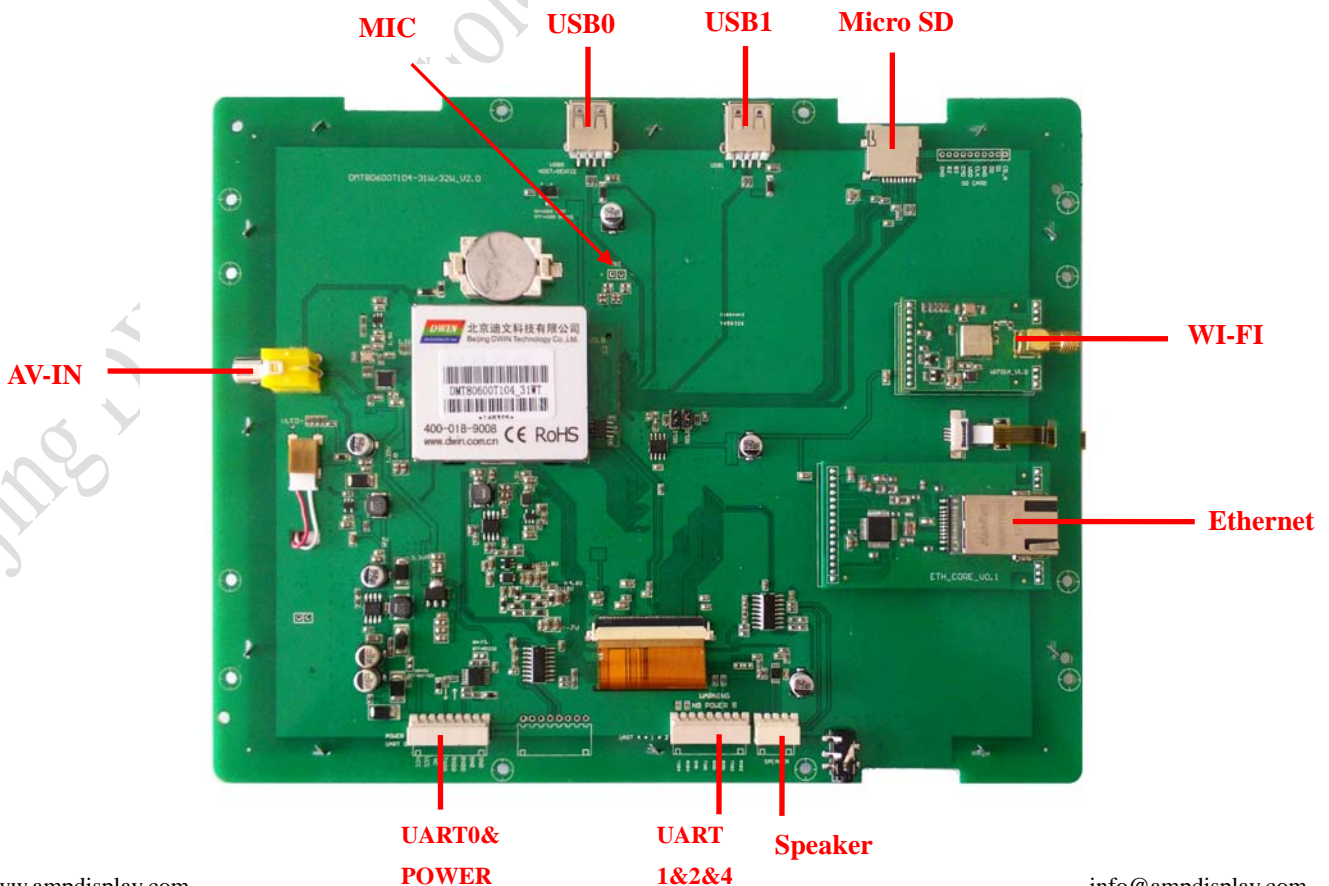

✧ *System Power*

The product is powered by an 8-pin interface marked as “UART0&Power”. There are two short-circuit pads on the board, which is marked as “ON=5V, OFF=6V-42V”

Status	Voltage
OFF	6V-42V
ON	5V

✧ *UART0&POWER Interface*

The TXD and RXD pins of UART0&Power are wired to “UART0&Power” connector. The UART0&Power supports TTL or RS232 voltage level. The definitions of the 8 pins of the UART0&Power connector are as marked on the board: VCC, VCC, NC (No Connect), TXD (output from the board), RXD (input to the board), RXD, GND and GND. There are two short-circuit pads on the board, which is marked as “ON=TTL, OFF=RS232”.

Status	Voltage level
OFF	RS232
ON	TTL

✧ *UART1&2&4Interface*

The TXD and RXD pins are wired to “UART1&2&4” connector. The interface supports RS232 voltage level. The definitions of the 8 pins of the UART1&2&4 connector are as marked on the board: RXD2, TXD2, RXD1, RXD1, TXD1, GND, RXD4 and TXD4.

✧ *External speaker interface*

The product provides one 4-pin 2.54mm-spacing socket connector marked “SPEAKER”. The schematic diagram is as follows:

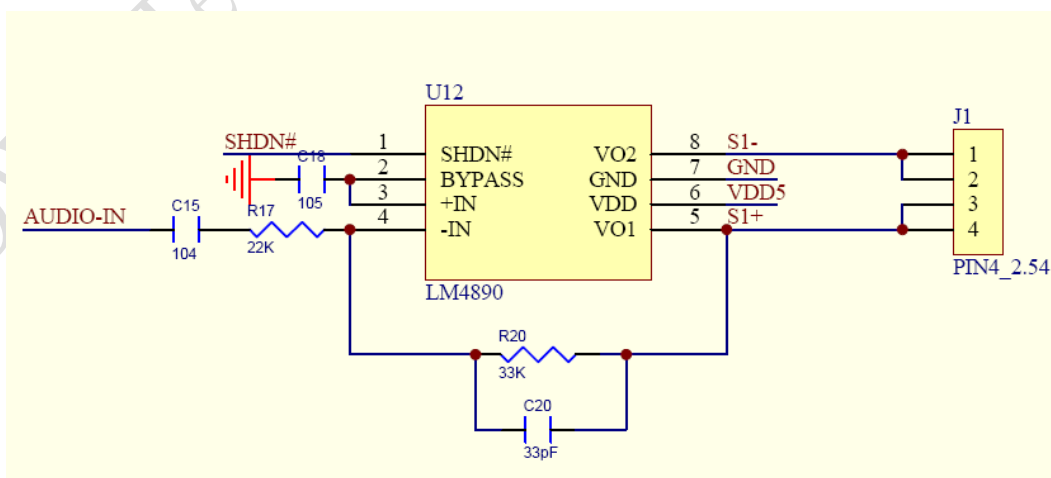

✧ *Microphone interface*

There are two wire interfaces near the top right corner of the core module marked as “MIC”.

#### ✧ *USB0 Interface*

The product provides one USB 2.0 interface. There are two short-circuit pads on the board, which is marked as “ON=USB0 HOST, OFF=USB0 DEVICE”.

Status	USB0 interface	Function
OFF	DEVICE	Connect to the PC
ON	HOST	Support USB 3G dongle, USB Camera, USB Disk, USB Keyboard, USB Mouse and etc

#### ✧ *USB1 Host Interface*

The product provides one USB 2.0 host, which can support USB 3G dongle, USB Camera, USB Disk, USB Keyboard, USB Mouse and etc.

#### ✧ *Micro SD card Interface*

The product provides one Micro SD card socket, which supports MMC4.2, SD2.0 and SDIO1.0 protocol.

#### ✧ *Analog Camera Interface*

The product provides one analog camera interface, which supports PAL/NTSC video format. The interface is provided as a yellow-color AV jack, which is marked as “AV-IN”.

#### ✧ *WIFI and Ethernet Interface*

The product provides single-band 2.4GHz IEEE 802.11b/g/n WIFI capability, which supports WEP, WAPI, WPA, WPA2, TKIP, AES and CKIP encryption. 10M/100M Ethernet is also provided.

### 3. Operating Guide

#### 3.1 Update the Boot Animation

1. Update boot animation using TF card

**Step 1:** Create a new folder named as “DWIN\_SET” in the root directory of a TF card, and then copy the “bootanimation.zip” file to the folder.

**Step 2:** Power on the product with the TF card inserted, and then there will be a reminder alerting accomplishment of updating. Remove the TF card and then restart; you will have the updated boot animation inside.

**Note:** the name of the boot animation must be “bootanimation.zip”.

2. How to make a boot animation

Please refer to the “bootanimation.zip”. After decompressing the file, please rename the target images in order to replace default files in the folder of animation part 0 or part 1. Then, compress this updated one again with noticing zip in format as showing following screen-shot.

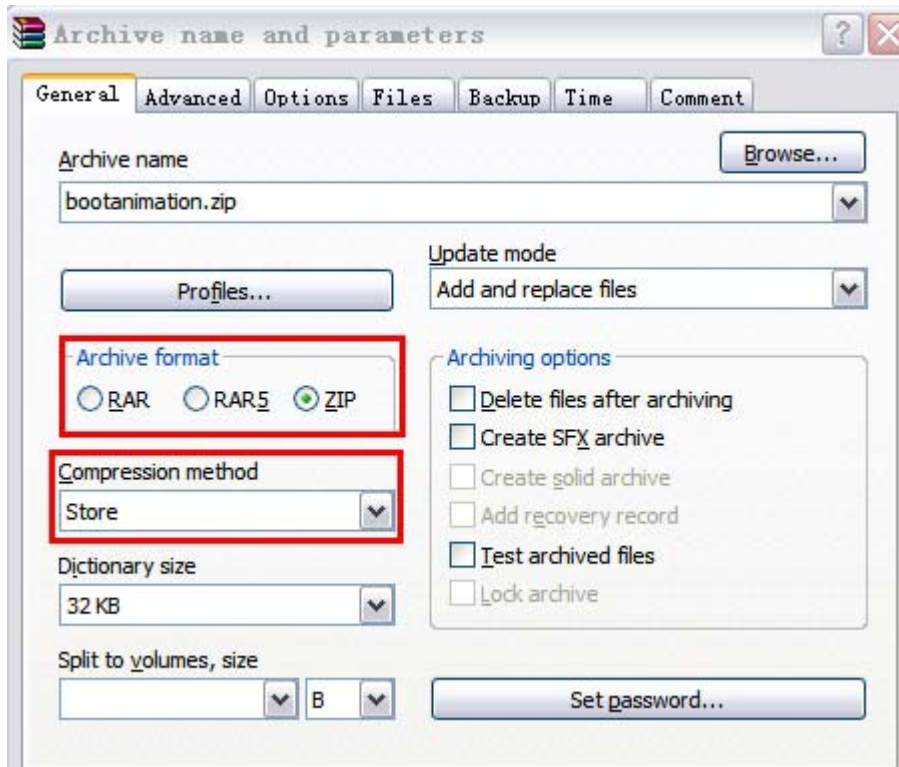

### 3.2 Hide / Show the Status Bar

1. Hide the status bar

**Step 1:** Create a new folder and named as “DWIN\_SET”. Create a file and named as “CONFIG.TXT” in the folder, then write: “HIDE\_NAVIGATION” in the file;

**Step 2:** Power on the product with the TF card inserted, and then there will be a reminder alerting accomplishment of hiding the status bar. Remove the TF card and then restart.

2. Show the status bar

Create a new folder and named as “DWIN\_SET”. Create a file and named as “CONFIG.TXT” in the folder, then write: “SHOW\_NAVIGATION” in the file. Other operations are the same as “1. Hide the status bar”.

### 3.3 Brightness

**Step 1:** Click **Settings** in the host pane and select **Display** on the left bar;

**Step 2:** Select **brightness**, Open the setup dialog box; adjust the brightness by dragging the progress bar. The left corresponds to the minimum brightness, and the right corresponds to the maximum brightness. AS shown in PIC 1.

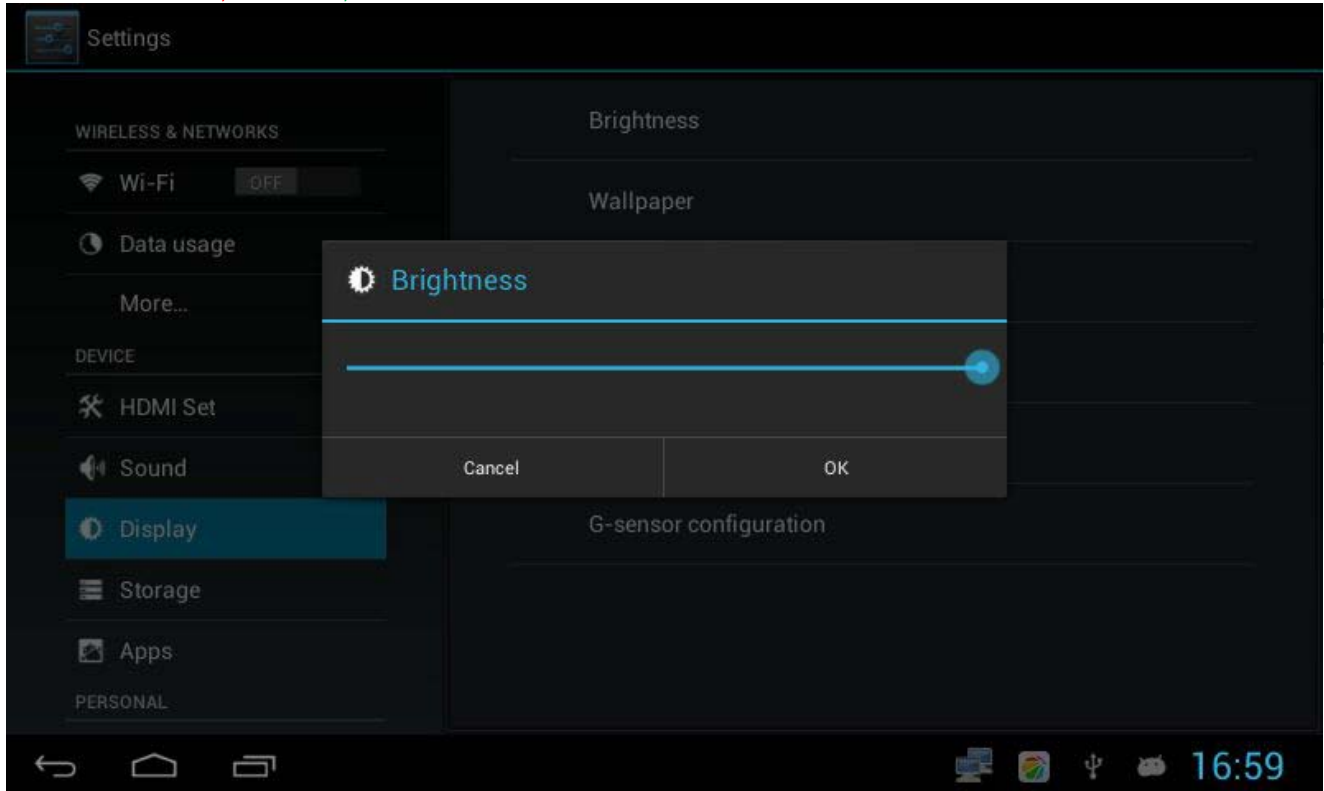

(PIC 1)

### 3.4 Sound

**Step 1:** Click **Settings** in the host pane and select **DEVICE** on the left bar;

**Step 2:** Click **Volume** to set all properties including video, audio, game and other Mediums as well as volume of alarm clock;

**Step 3:** Set **Touch sounds** and **Screen lock sounds**, when is checked, it means the tone is turned on, and otherwise, turned off.

### 3.5 WI-FI

The farthest distance of the wireless network is 300 feet (100M), with 2.4G Hz antenna.

**Note:** The availability and range of WI-FI signal depend on the number, the infrastructure, and other objects that the signal may penetrate.

Enable WIFI and connect to a wireless network:

**Step 1:** Click **Settings** in the host pane and select **WIRELESS & NETWORKS** on the left bar;

**Step 2:** Slip the internet status from **OFF** to **ON**. In the WI-FI network list you can scan the network name and its security settings (open network or secured with WEP, WPA/WPA2). If the Network notification is available and there is an available open network nearby, the status bar will show the ICON . As shown in PIC 2.



(PIC 2)

**Step 3:** Choose one network from the WI-FI network list, if the network is open, the product will connect it automatically; if the network is secured with WEP, WPA or WPA2, you must enter the password before connecting to the network;

**Step 4:** After connecting the network, the status bar will show the ICON and the approximate signal strength (depending on the number of strip lights);

**Step 5:** If you want to remove the wireless networks already settled, click it, and then choose “cancel save”. The next time you want to connect to the network, you must re-enter the password and set again.

### 3.6 Ethernet

10M/100M Ethernet is available. Before plugging the internet cable, the statuses bar shows the ICON

**Step 1:** Plug the internet cable, the status bar will show the name of the network and the ICON . If not, please confirm whether the pilot lamp of the network interface is flashing. If it is not flashing, please check whether the interface cable is securely plugged or the interface cable is qualified;

**Step 2:** Click **Ethernet Manager** in the host pane;

**Step 3:** Click **Configure Ethernet** under the **Configure network**. There are two options: 1.automatically assign an IP



address, 2.manually enter the IP address. As shown in PIC 3.

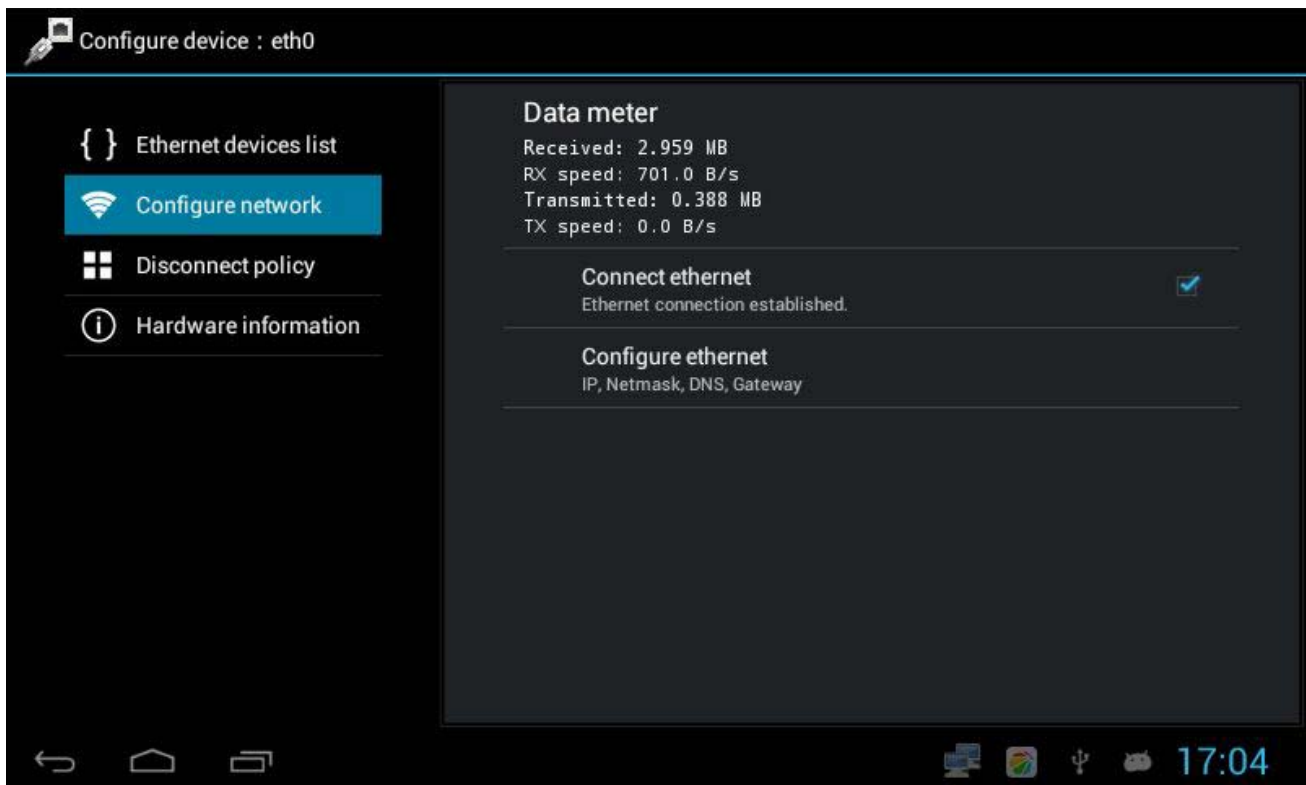

(PIC 3)

**Step 4:** Click **Connect Ethernet**. After accomplishing, we can view the **Received, RX speed, Transmitted and TX speed** in the Data meter;

**Step 5:** The memory will be saved in the system automatically. If reconnect the same Ethernet next time, there is no need to set the IP address again, just plug the Internet cable, it will be connected automatically.

### 3.7 3G Mobile Manager

The underlying drivers and tool software of 3G network has been installed in the system.

**Step 1:** Plug the 3G card in the USB 1 interface or the USB 0 interface if the status of USB 0 is in the HOST status, the status bar will show the ICON “**3G**”. If the “3G” can’t be recognized, please confirm if the pilot lamp flashes or not. If the warning lamp flashes but the status bar does not show the ICON “**3G**”, please check in the Modem list and confirm if this 3G card belong to the types that this system support;

**Step 2:** Click **3G Mobile Manager** in the host pane;

**Step 3:** Under the **Network Status >Disclaimer**, current network operators can be found, such as “China Telecom network”. Select **Connect to network**;

**Step 4:** In the Modem list, all types of 3G card that current systems support can be checked, which is as shown in the list below:

NAME	TYPE
HUAWEI-E1750	WCDMA USB dongle
HUAWEI-EC156	CDMA2000 USB dongle
HUAWEI-E261	WCDMA USB dongle
HUAWEI-EC122	CDMA2000 USB dongle
HUAWEI-EC1261	CDMA2000 USB dongle
HUAWEI-EC1270	CDMA2000 USB dongle
HUAWEI-E176G	WCDMA USB dongle
HUAWEI-EM770	WCDMA USB onboard
HUAWEI-Q24Plus	GPRS UART onboard
ZTE-AC2746	CDMA2000 USB dongle
ZTE-AC2736	CDMA2000 USB dongle
ZTE-AC580	CDMA2000 USB dongle
ZTE-A356	TD-SCDMA USB dongle
ZTE-MF637U	WCDMA USB onboard
ZTE-AD3812_V3	WCDMA USB onboard
ZTE-MG3732	WCDMA USB onboard
Speedup-SU9800	WCDMA USB onboard
Speedup-SU8650	WCDMA USB onboard
Speedup-SU8900	WCDMA USB onboard
Speedup-SU7300	CDMA2000 USB dongle
Titan-HSPA2100HZ	WCDMA USB onboard

### 3.8 File Manager

**Step 1:** Click **File Manager** in the host pane;

**Step 2:** We can view all the folders of the system and external storage devices;

**Step 3:** **Micro-SD** corresponds to the folder “sdcard1”, **USB 1** corresponds to the folder “USB\_host/disk1”, and **USB 0** corresponds to the folder “disk/disk-1”.

### 3.9 Install and Uninstall Applications

Install applications:

**Step 1:** Find the application that you want to install in the file manager;

**Step 2:** Click it to start the installation. If the system prompted a dialog box named as “Install blocked”, open **Settings>PERSONAL>Security>DEVICE ADMINISTRATION**, then select the option which means “Unknown sources: allow installation of apps from unknown sources”. As shown in PIC 4.

Uninstall applications:

**Step 1:** Click **Settings** in the host pane;

**Step 2:** Open **DEVICE>Apps**, then we can view all the applications which are already installed;

**Step 3:** Click the application that you want to uninstall, the screen prompts two options: **Force stop** and **Uninstall**, choose **Uninstall**.

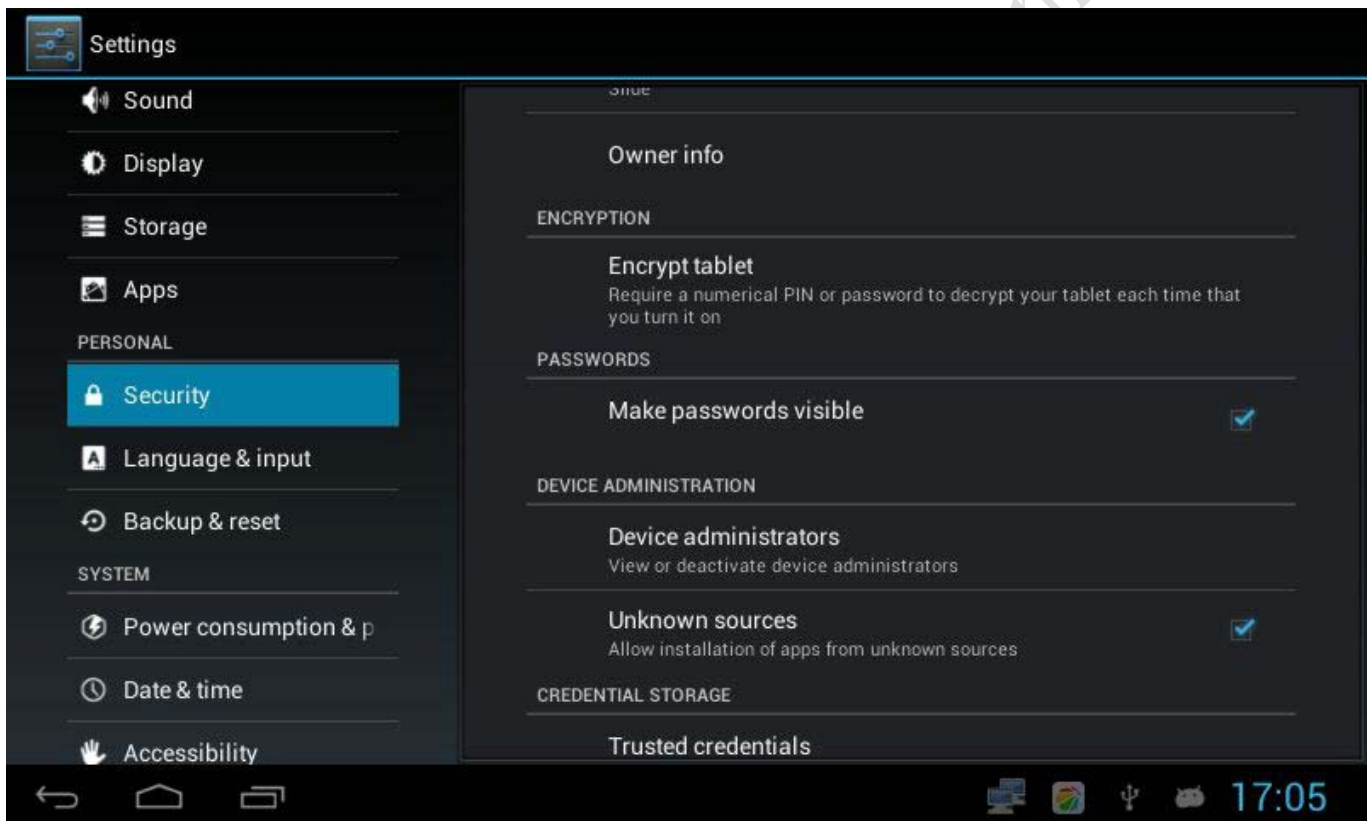

(PIC 4)

### 3.10 Show Touches

**Step 1:** Click **Settings** at host pane;

**Step 2:** Open **SYSTEM>Developer options**, select the option “**Show touches: show visual feedback for touches**”.

### 3.11 Touch-screen Calibration

**Step 1:** Create a new folder and named as “DWIN\_SET”. Create a file and named as “CONFIG.TXT” in the folder, then write: “TP\_CORRECT” in the file;

**Step 2:** Copy the folder “DWIN\_SET” to the root directory of U disk or SD card, and then insert the U disk or SD card into the product. After the system reads the file “CONFIG.TXT”, the touch-screen calibration starts;

**Step 3:** Click the screen according to the cross line shown as “+”;

**Step 4:** After finishing the calibration, the system will automatically return to the picture before the calibration.

*Note: applies only to a resistive touch panel*

### 3.12 Serial Testing

Test the communication between the Android product and the computer:

**Step 1:** Connect the UART0 of Android to the user's computer via a serial cable;

**Step 2:** Open “**Android Serial Port Tool**” with COM0 selected as communication port, The Port 1, 2, 4 on UART1&2&4 are in accordance with COM1, COM2, and COM4. Then, check on options in baud rate, data, stop, checksum and click “CLOSE” for activating status of serial port. As shown in PIC 5.

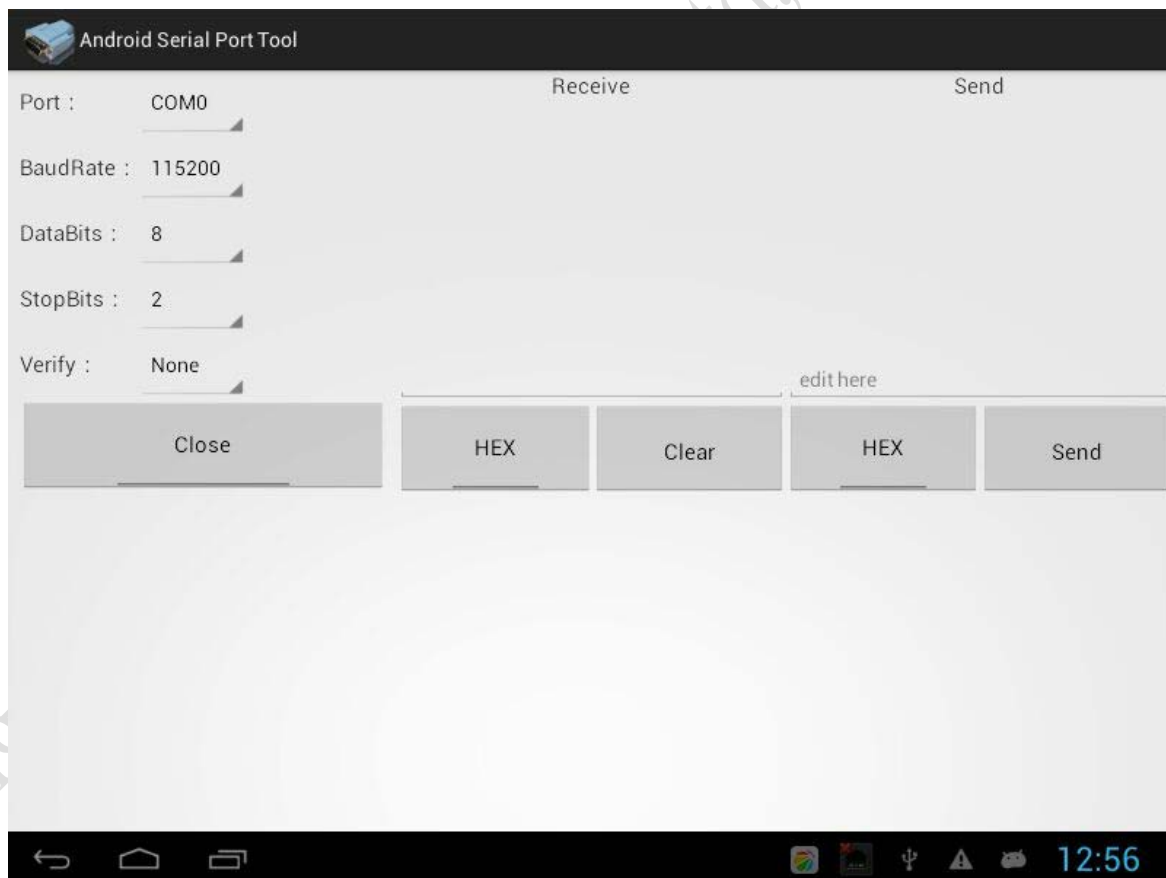

PIC 5

**Step 3:** Open serial-debugger **SSCOM32** and check serial number, baud rate, and data in options according to Device Manager in purpose of staying the same set as **Android Serial Port Tool**;

**Step 4:** Write command in **Android Serial Port Tool** to see if corresponded correctly in **SSCOM32**. Oppositely, you are allowed to have reversed operation which is command composing in **SSCOM32** but monitoring if received in **Android Serial Port Tool**.

### 3.13 Connect to PC

**Step 1:** Set the status of the “USB 0 interface” as “OFF” refer to the *USB0 interface* in the chapter 2. As shown in PIC 6.

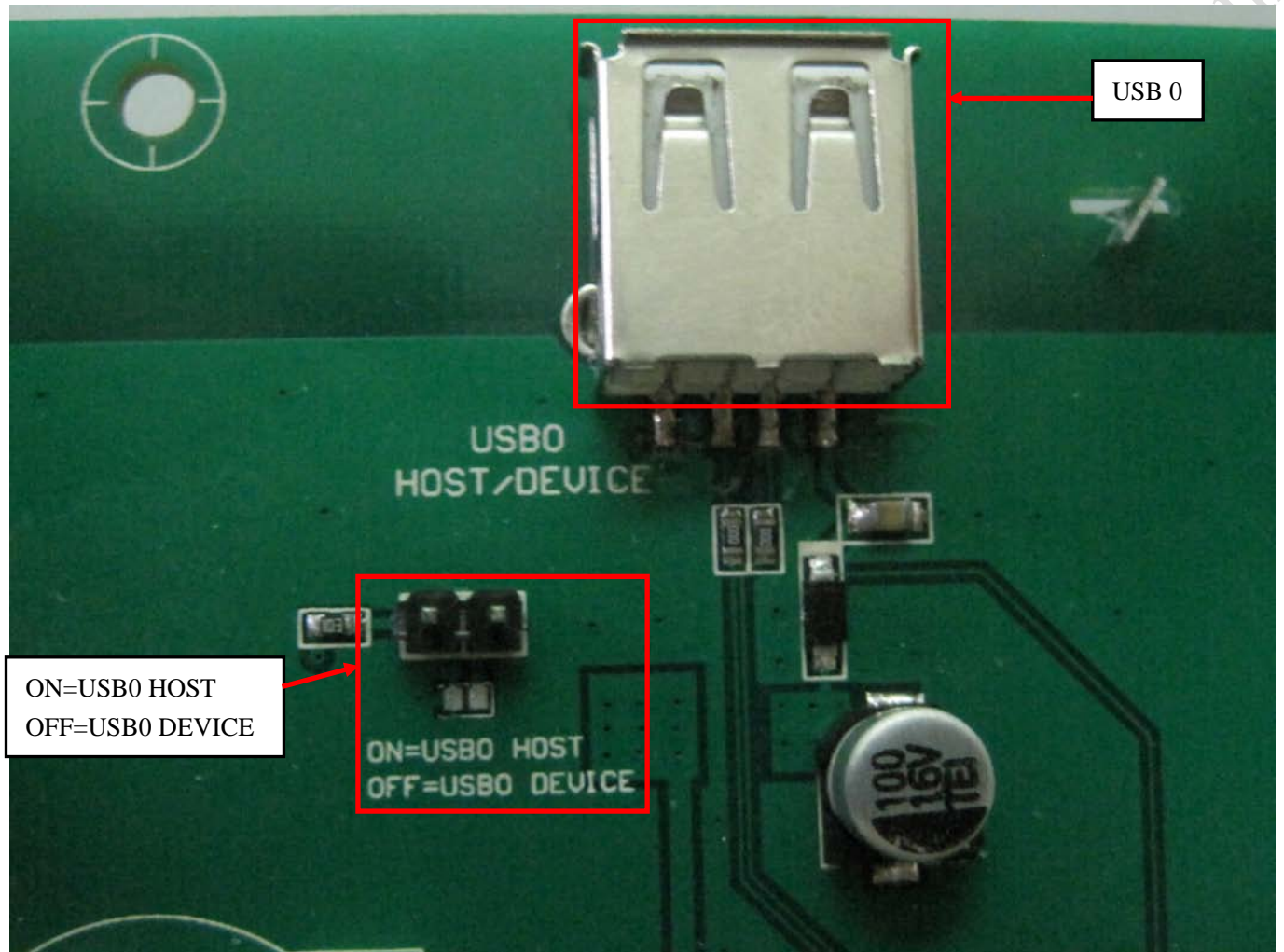

PIC 6

**Step 2:** Connect the Android screen to the PC with Male-to-Male USB cable;

**Step 3:** Check the “Device Manager” on the PC, whether the “**Android device**” is detected; Please try again after installing the driver if there is nothing detected;

**Step 4:** For the driver download, please connect the PC to the internet, download and install the software “Snap Pea”;

**Step 5:** Reconnect and check the detection status. The connection is successful if the “Android device” is found.

### 3.14 Backup & Reset

Open **Settings >Backup and Reset >personal**, there are two options: **Factory data reset** and **System Upgrade**. Note:

All the data on the device will be erased by choosing “**Factory Data Reset**”. As shown in PIC 7.

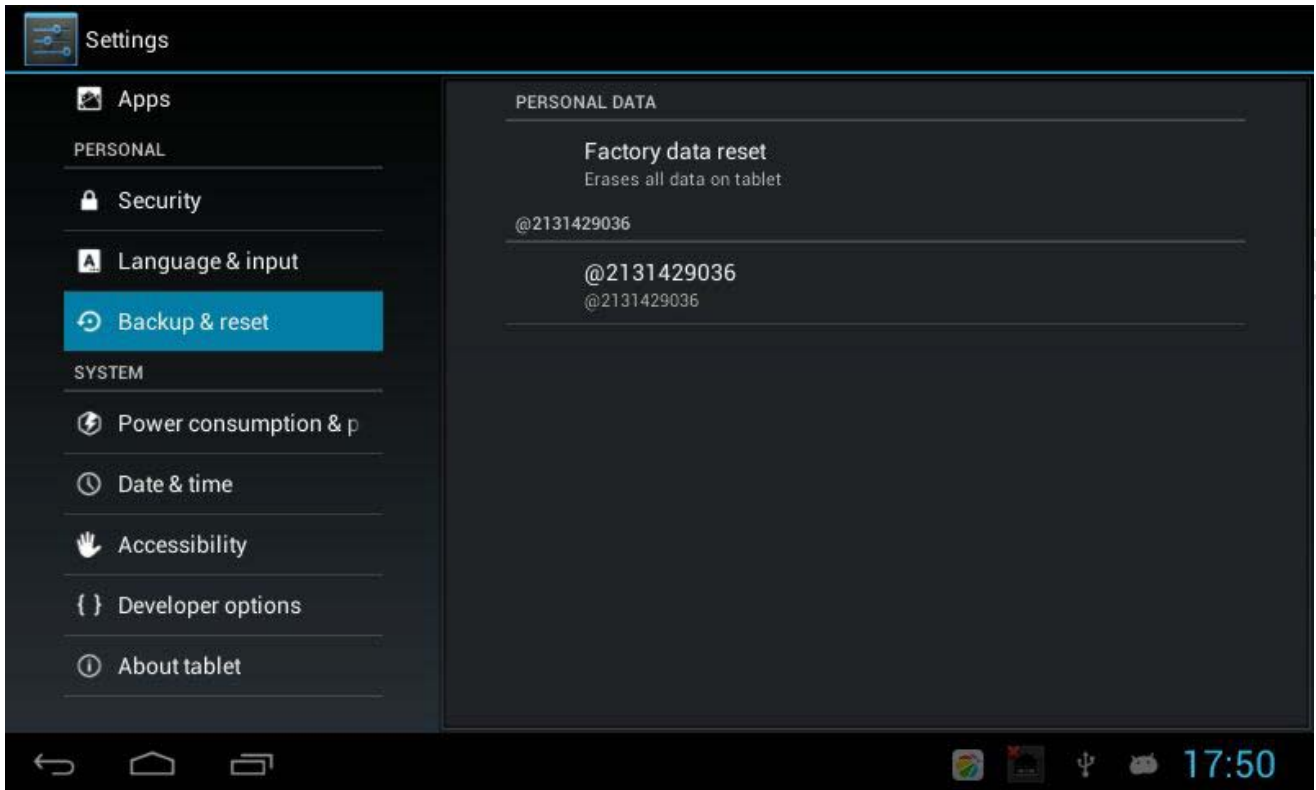

PIC 7

*Tips: calibrate the touch screen after the “Factory data reset”*

#### 4. Revision

Date	Revised Contents	Edition
2014.4.3	First release	V1.0
2014.4.15	Add “3.2 Hide / Show Status Bar”	V2.0